

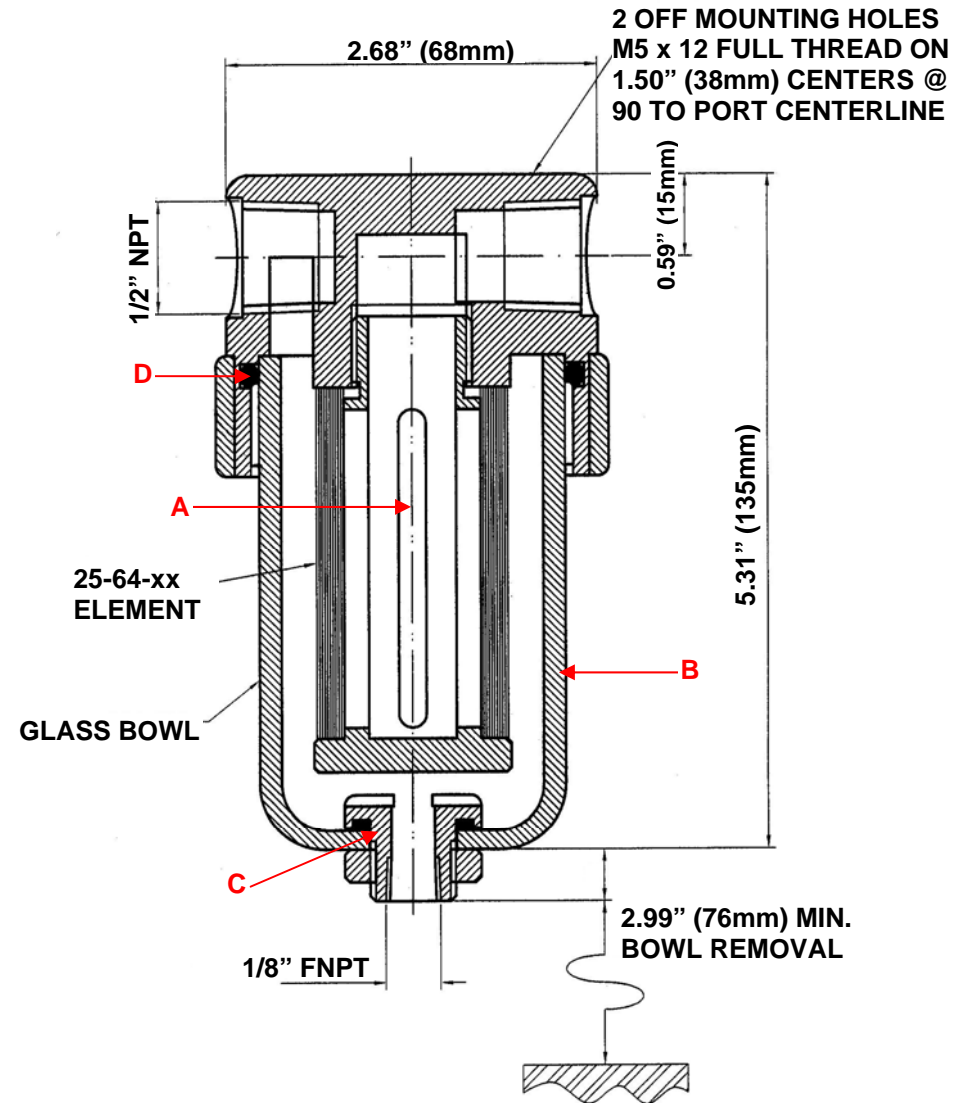

Model: 132PG (1/2" NPT)

Replacement Parts List

25-64-xx	Disposable Filter Element
SS-25-64-xx	Stainless Steel Filter Element
PT-25-64-xx	PTFE Filter Element
PEL-25-64-xx	PEL Filter Element
TR130P	Tie Rod w/ Element Retainer (A)
SC130P	Support Core (Not Pictured)
GB130PG	Pyrex Bowl (B)
BHF130PG	Bulk Head Fitting (PTFE) (C)
MBSS130	Mounting Bracket (Not Pictured)
Oxygen Cleaning Service Available Note – Please replace "xx" with micron rating or grade	
Available O-Rings	
BN130PG	Buna-N
GV130PG	Viton (Standard) (D)
KZ130PG	Kalrez
GS130PG	Silicone



 <p>United Filtration Systems, Inc. 6558 Diplomat Drive Sterling Heights, MI 48314 1-800-311-5561 www.unitedfiltration.com</p>	Model 132PG		<p>THE COPYRIGHT OF THIS DRAWING IS RESERVED BY UNITED FILTRATION. IT IS ISSUED ON CONDITION THAT IT IS NOT COPIED, REPRODUCED OR DISCLOSED TO A THIRD PART EITHER WHOLLY, OR IN PART WITHOUT CONSENT IN WRITING.</p>
	<p>Material: Head: PTFE Bowl: Pyrex Internals: PTFE Standard Gasket / O-ring: Viton</p>	<p>Drain Type: 1/8" FNPT Maximum Temperature: 400 Maximum Pressure: 100 Internal Volume: 155</p>	
<p>DO NOT SCALE DRAWING IF IN DOUBT ASK</p>			